

(Mark)	(Qty.)	(EC Content)	(EC Reason)	(EC No.)	(Date)	(Proposer)
△a						
△b						
△c						

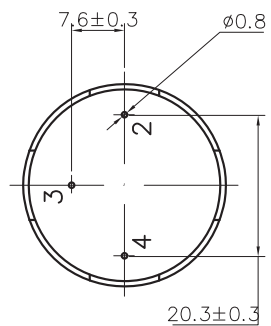

BOTTEM VIEW

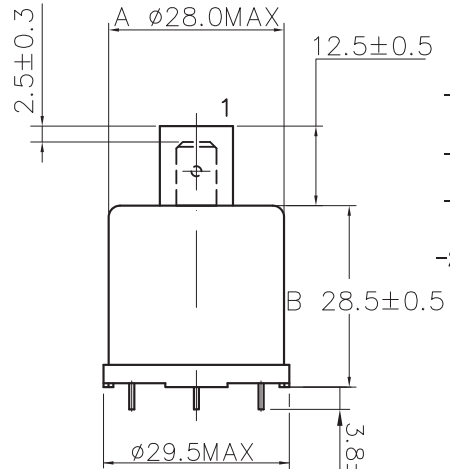

SIDE VIEW

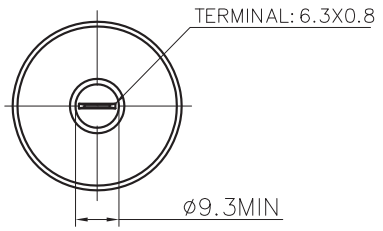

TOP VIEW

When the test voltage is 220V 50Hz, such as FIG.2 voltage and pulse width.

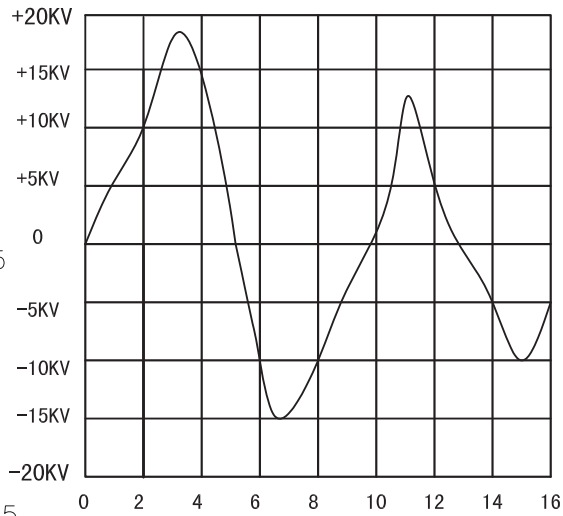

TYPICAL WAVEFORM AT THE H.V. POINT WITH PULSE WIDTH IN THE TRANSFORMER INTO A 20PF LOAD  
FIG.2

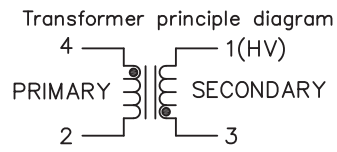
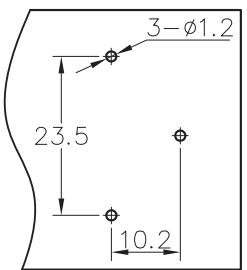

FIG. 3



PCB FIX SIZE

NOTES:

- 1.PRIMARY: 10± 1/2 TURN 1UEW-0.45;
- 2.SECONDARY: 3420 TURN 1UEW-0.057;
- 3.HYPOT 1250VAC. BETWEEN PRIMARY AND SECONDARY;
- 4.THE USE OF TEMPERATURE - 40~85 ° C;
- 5.FILL MATERIAL: EPOXY,VACUUM FORMED;
- 6.PEAK PRIMARY CURRENT: 60 AMPS;
- 7.ADDITIONAL ELECTRICAL SPEC'S.(FOR REF.ONLY)  
PRIMARY: 0.04OHMS ± 25%,5uH ± 30%;  
SECONDARY:1150 OHMS ± 25%, 340mH ± 30%;  
MEASURED AT 1KHz,75° F
- 8.SPARK VOLTAGE: 18± 3KV(CL=20PF);  
DISCHARGE PULSE:5± 2us;
- 9.INSULATION RESISTANCE >100M OHMS;
- 10.OUTPUT TERMINAL BY TENSION TEST,  
DRAWING FORCE GREATER THAN 3kgf.cm;
- 11.OUTPUT TERMINAL WITH A TORSION  
TESTER,TORQUE GREATER THAN 8kgf.cm.

TEST CIRCUIT FOR REFERENCE ONLY

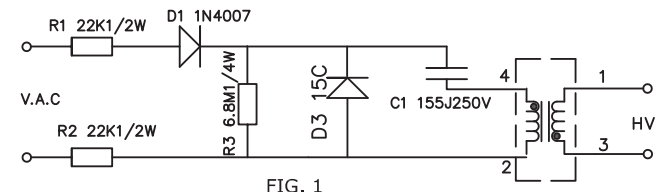

FIG. 1

NOTES:AB points between the trigger voltage is 150V

MAP	A4	PAGE	1	FIRST CORNER		PRODUCT	HT	
UNIT	mm	SCALE	1:1			MATERIAL NO.	4010-007	
<b>GEI Inc.</b> www.gei-inc.com				APPROVE		DRAWING NO.	4.010.007	
				CHECK		DRAWING NAME	Finished product	
				DESIGN		DRAWING NO.		1.0